

(19) World Intellectual Property
Organization
International Bureau



(43) International Publication Date
2 September 2004 (02.09.2004)

PCT

(10) International Publication Number
WO 2004/073550 A2

- (51) International Patent Classification⁷: A61F
- (21) International Application Number: PCT/US2004/004596
- (22) International Filing Date: 17 February 2004 (17.02.2004)
- (25) Filing Language: English
- (26) Publication Language: English
- (30) Priority Data: 60/448,599 20 February 2003 (20.02.2003) US
- (71) Applicant and
- (72) Inventor: MURRAY, Ian, P. [US/US]; 14351 Hampshire Knob Drive, Phoenix, MD 21131 (US).
- (74) Agent: GAMSON, Robert, M.; Armstrong, Kratz, Quintos, Hanson & Brooks, LLP, Intellectual Property Law Offices, 502 Washington Avenue, Suite 220, Towson, MD 21204 (US).

(81) Designated States (unless otherwise indicated, for every kind of national protection available): AE, AG, AL, AM, AT, AU, AZ, BA, BB, BG, BR, BW, BY, BZ, CA, CH, CN, CO, CR, CU, CZ, DE, DK, DM, DZ, EC, EE, EG, ES, FI, GB, GD, GE, GH, GM, HR, HU, ID, IL, IN, IS, JP, KE, KG, KP, KR, KZ, LC, LK, LR, LS, LT, LU, LV, MA, MD, MG, MK, MN, MW, MX, MZ, NA, NI, NO, NZ, OM, PG, PH, PL, PT, RO, RU, SC, SD, SE, SG, SK, SL, SY, TJ, TM, TN, TR, TT, TZ, UA, UG, US, UZ, VC, VN, YU, ZA, ZM, ZW.

(84) Designated States (unless otherwise indicated, for every kind of regional protection available): ARIPO (BW, GH, GM, KE, LS, MW, MZ, SD, SL, SZ, TZ, UG, ZM, ZW), Eurasian (AM, AZ, BY, KG, KZ, MD, RU, TJ, TM), European (AT, BE, BG, CH, CY, CZ, DE, DK, EE, ES, FI, FR, GB, GR, HU, IE, IT, LU, MC, NL, PT, RO, SE, SI, SK, TR), OAPI (BF, BJ, CF, CG, CI, CM, GA, GN, GQ, GW, ML, MR, NE, SN, TD, TG).

[Continued on next page]

(54) Title: KNEE SPACER

WO 2004/073550 A2

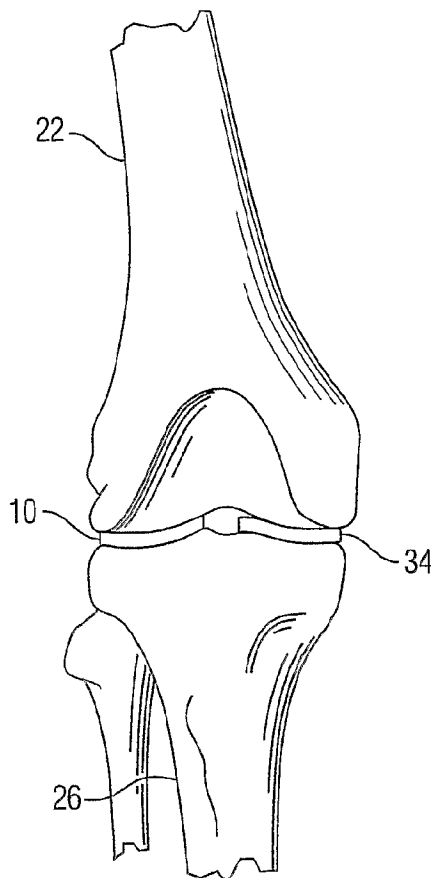

(57) Abstract: A spacer for use in a knee which is kidney-shaped and has a concave femoral surface and an opposite convex tibial surface. A pair of non-identical spacers are provided for a knee. One spacer is disposed laterally and the other is disposed medially in the knee. The spacers may be formed in a variety of sizes to be adapted to patients of different sizes. The spacers may be formed for the right knee and for the left knee.



Declaration under Rule 4.17:

— *of inventorship (Rule 4.17(iv)) for US only*

Published:

— *without international search report and to be republished upon receipt of that report*

For two-letter codes and other abbreviations, refer to the "Guidance Notes on Codes and Abbreviations" appearing at the beginning of each regular issue of the PCT Gazette.

KNEE SPACER

BACKGROUND OF THE INVENTION

Field of the Invention

The Unicondulator Interpositional Spacer is intended for use in the Osteoarthritic knee,
5 where substantial amounts of articular cartilage have been lost as a result of the disease.

The prostheses will be used in indications for uncemented treatment of the Tibia
articulating surfaces (Medial and Lateral) of the following:

10 Moderate degeneration of the Medial and/or Lateral
compartment of the knee (grade II-IV chondromalacia) and
minimal degeneration (grade I-II chondromalacia, no loss
of joint space) in the patellofemoral components.

Description of Related Art

The spacer is intended as an alternative to arthroscopy, high tibial osteotomy (HTO), and
knee arthroplasty treatments for those situations where limited degeneration joint destruction
15 exists.

Arthroscopic procedures are currently performed to address the pain and synovitis
associated with early stage osteoarthritis. Many patients have Grade II-IV chondromalacia and
failure may occur within two years in half of those treated arthroscopically only. While the
effectiveness of arthroscopic debridement is quite variable, it was found, that it does not address
20 the mechanical alignment and laxity problems associated with the joint. Use of other options,
such as knee arthroplasty and HTO, are more invasive, technically challenging and may
compromise the joint to future treatment options. Anti-inflammatory medications have also
been used to manage pain, but have limited effect on moderate arthritis and offer no solution in
terms of repair to the knee joint. Repair has generally been directed to the delridament of soft
25 tissue as in arthroscopy or reheating valuable unaffected bone and cartiledge.

Fell et al in U.S. Patent No. 6,206,927 disclose a metal surgically-implantable knee
prosthesis. However, the prosthesis is custom tailored for the individual patient and has non-
uniform thickness. A more generally applicable prosthesis is needed.

BRIEF SUMMARY OF THE INVENTION

30 It is an object of the present invention to provide a prosthesis for arthritis of the knee.

It is a further object of the present invention to provide a relatively inexpensive, simple
device to be used in the knee of a patient.

In accordance with the teachings of the present invention there is disclosed a spacer for use in a knee being a kidney-shaped device having a femoral surface which is concave and an opposite tibial surface which is convex. The spacer has a uniform thickness between the femoral surface and the tibial surface. The femoral surface is the complementary mirror image of the tibial surface. The tibial surface has a cusp formed thereon, the cusp being oriented away from the femoral surface.

These and other objects of the present invention will become apparent from a reading of the following specification taken in conjunction with the enclosed drawings.

BRIEF DESCRIPTION OF THE DRAWINGS

- 10 FIG. 1 is a top plan view of the lateral spacer.
FIG. 2 is an end elevation view of the posterior side of the lateral spacer.
FIG. 3 is a side elevation view of the medial side of the lateral spacer.
FIG. 4 is a cross-section view taken across the lines 4-4 of FIG. 1.
FIG. 5 is a partial end elevation view of the anterior side of the lateral spacer showing
15 bores therein.
FIG. 6 is a top plan view of the medial spacer.
FIG. 7 is an end elevation view of the posterior side of the medial spacer.
FIG. 8 is a side elevation view of the medial side of the medial spacer.
FIG. 9 is a cross section view taken across the lines 9-9 of FIG. 6.
20 FIG. 10 is a partial end elevation view of the anterior side of the medial spacer showing bores therein.

FIG. 11 is a view of the posterior of the right knee showing the lateral spacer and the medial spacer disposed between the femur and the tibia.

25 FIG. 12 is a top plan view of the lateral and medial spacers disposed on top of the tibia of the right leg.

FIG. 13 is a perspective view of the spacer in the knee when the knee is flexed.

DESCRIPTION OF THE PREFERRED EMBODIMENTS

Referring now to FIGS. 1-5 the lateral spacer 10 has an anterior side 12, a posterior side 14, a lateral side 16 and a medial side 18. The lateral spacer 10 has a femoral surface 20 which is in contact with the lateral side of the femur 22 of the patient when inserted in the knee. The
30 lateral spacer 10 also has a tibial surface 24 which is in contact with the lateral side of the tibia

26 of the patient when inserted in the knee. The femoral surface 20 is concave and the tibial surface 24 is convex. The lateral spacer 10 has uniform thickness between the femoral surface 20 and the tibial surface 24 such that the femoral surface 20 and the tibial surface 24 are complementary mirror images of each other. A pair of spaced-apart bore holes 28 are formed in the anterior side 12 of the lateral spacer 10. An instrument (not shown) is received in the two bore holes 24 to hold the lateral spacer 10 when the spacer is being placed in the knee. At least one cusp 30 is formed on the lateral spacer 10. Preferably, an anterior cusp 30 and a posterior cusp 30' are formed. The cusps 30, 30' are oriented away from the tibial surface 24 forming an arch 32 therebetween.

Referring now to FIGS. 6-10, similarly the medial spacer 34 has an anterior side 36, a posterior side 38, a lateral side 40 and a medial side 42. The medial spacer 34 has a femoral surface 44 which is in contact with the medial side of the femur 22 when inserted in the knee. The medial spacer 34 also has a tibial surface 46 which is in contact with the medial side of the tibia 26 of the patient when inserted in the knee. The femoral surface 44 is concave and the tibial surface 46 is convex. The medial spacer 34 has uniform thickness between the femoral surface 44 and the tibial surface 46 such that the femoral surface 44 and the tibial surface 48 are complementary mirror images of each other. As in the lateral spacer 10, the medial spacer 34 also has a pair of spaced-apart bore holes 24 formed in the anterior side 36 of the medial spacer 34. The same instrument (not shown) can be used to hold both the lateral spacer and the medial spacer 34. At least one cusp 48 is formed in the medial spacer 34. Preferably an anterior cusp 48 and a posterior cusp 48' are formed. The cusps 48, 48' are oriented away from the tibial surface 46 forming an arch 50.

Although the lateral spacer 10 and the medial spacer 34 have generally similar configurations, the spacers are not identical and are not interchangeable.

FIG. 11 shows the lateral spacer 10 and the medial spacer 34 disposed between the femur 22 and the tibia 26 in the right knee of a patient as viewed posteriorly. It is clear that the spacers support the femur and are in direct contact with the knee. FIG. 12 is a top plan view of lateral spacer 10 and the medial spacer 34 in the right leg of the patient. The thickness of the spacers 10, 34 is uniform in the medial/lateral and anterior/posterior aspects.

It is preferred that the spacers be formed from an alloy of chromium, cobalt and molybdenum. Implants using this alloy have superior resistance to corrosion, high fatigue

strength, and outstanding biocompatibility. The tibial surface and the femoral surface of the spacers are highly polished to slide freely against the surfaces of the knee (e.g., the tibia and the femur).

5 The spacers 10, 34 are small, metallic kidney-shaped inserts that are intended to restore stability and normal alignment for patients with early arthritis. The shape of the implant is similar to the natural anatomy of the tibia and femoral condyles of the knee. The implant geometry will allow some motion during flexion but will lock in the proper position under load at extension thereby relieving the feeling of "dislocation" caused by other free floating implants on the current orthopedic market. The implant conforms to the natural bone structures and stays
10 in place without bone cement or screws. The implantation of the spacer does not require bone cuts. It is asymmetric, having left and right components, medial and lateral configurations, and may be made available in several sizes in 1mm increments in implant thickness (approximately 1-6mm) to better restore joint alignment, tension and stability. The array of sizes accommodate variations in human anatomy and increase intra-operative versatility. The various sizes conform
15 as closely as possible to the weight and size of each patient. The implant design is kidney-shaped to mimic the medial and lateral condyles of the femur. The tibial surfaces are congruent to the plateau on the tibia. The corners of the spacers 10, 34 are smooth and rounded to avoid stress risers and implant malfunction.

The spacers 10, 34 are not permanent prosthesis but are intended to be used to provide
20 relief for the condition where the cartilage between the femur and tibia has been worn or damaged. The use of the spacers 10, 34 will delay the time for a full knee replacement for various times depending upon the age of the patient and the extent of damage in the knee. In most patients, the medial side of the knee wears or is damaged before the lateral side. At the present time, many surgeons repair only the medial side of the knee. This often results in
25 accelerated damage to the lateral side of the knee and the need for full knee replacement at an earlier date.

The present invention provides a lateral and a medial spacer as a pair to be inserted simultaneously in the knee of the patient. The damages are not the same in each patient or even in the legs of the same patient. The spacers of uniform thickness when inserted in the knee(s) of
30 the patient, accommodate the irregularities in damage and do not require custom shaping as do the prosthesis of *Fell et al* (6,206,927) which do not have a uniform thickness.

The spacers are used by anteriorly making a minimally invasive incision in the knee to provide access to the knee at the interface between the femur and the tibia. The femur and tibia are forced apart extending the ligaments. Using the special instrument, which is received in the bore holes (24, 28) in the spacers, the spacers 10, 34 are slid between the femur and the tibia.

5 Because of the highly polished surfaces of the spacer and the uniform thickness, the spacers are very easily inserted. Similarly, if the spacers are to be removed, they are easily withdrawn. No cement or adhesive is used with the spacers of the present invention. The uniformly thick spacers are substantially congruent with the faces of the femur and the tibia (excluding irregular wear portions). Thus, with the tension provided by the ligaments 52, the uniformly thick spacers
10 are not ejected from between the tibia and femur when the knee is flexed (FIG. 13).

Because of their uniform thickness, the spacers of the present invention will fit the knee of a larger percentage of the population than can be fitted with spacers custom made and/or having non-uniform thickness.

The spacers 10, 34 are designed to fill the space between the diseased tibia
15 compartments, medial and/or lateral and intended to:

- Decrease pain
- Restore knee alignment
- Improve joint stability
- Restore ligament tension
- 20 • Avoid or delay Total Knee Arthroplasty
- Help restore patient activity level

the devices may be sold sterile, sterilized by gamma Irradiation at 2.5 MEADS minim.

Obviously, many modifications may be made without departing from the basic spirit of the present invention. Accordingly, it will be appreciated by those skilled in the art that within
25 the scope of the appended claims, the invention may be practiced other than has been specifically described herein.

CLAIMS

1. A spacer for use in a knee comprising:
a kidney-shaped device having a femoral surface which is concave and an
opposite tibial surface which is convex,
5 the spacer having uniform thickness between the femoral surface and the tibial
surface,
such that the femoral surface is the complementary mirror image of the tibial
surface,
the tibial surface having at least one cusp formed thereon, the at least one cusp
10 being oriented away from the tibial surface.
2. The spacer of claim 1, wherein the device is configured to be adapted to a lateral
side of the knee.
3. The spacer of claim 1, wherein the device is configured to be adapted to a medial
side of the knee.
- 15 4. The spacer of claim 1, wherein the spacer is formed from a chromium, cobalt,
molybdenum alloy.
5. the spacer of claim 1, wherein the spacer has highly polished surfaces to slide
freely against the surfaces of the knee.
6. The spacer of claim 1, wherein the spacer is formed in a plurality of sizes to be
20 adapted to variations in the human anatomy.
7. The spacer of claim 1, having an anterior side, a pair of spaced-apart bore holes
being formed in the anterior side, wherein an instrument may be received in the bore holes to
hold the spacer when the spacer is placed in the knee.
8. A pair of spacers for use between the femur and the tibia in a knee comprising:
25 a medial spacer configured to be adapted to a medial side of the knee,
a lateral spacer configured to be adapted to a lateral side of the knee,
each spacer having a femoral surface which is concave and/or opposite tibial
surface which is convex,
each spacer having uniform thickness between the femoral surface and the tibial
30 surface,
the medial spacer being different from the lateral spacer,

wherein the medial spacer and the lateral spacer are disposed in the knee to prevent contact between the femur and the tibia.

9. The pair of spacers of claim 8, to be adapted to the right knee.
10. the pair of spacers of claim 8, to be adapted to the left knee.
- 5 11. The pair of spacers of claim 8, adapted to the right knee and an additional pair of spacers adapted to the left knee, the two pairs of spacers being mirror images of each other.

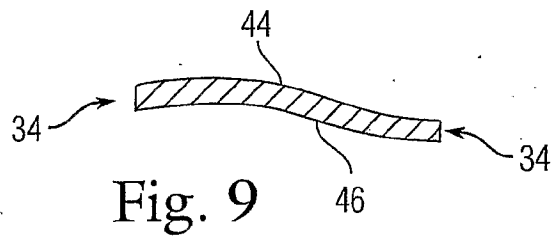
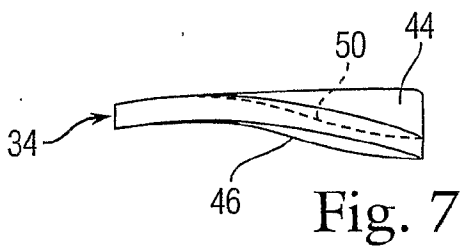
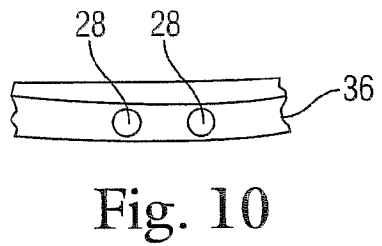
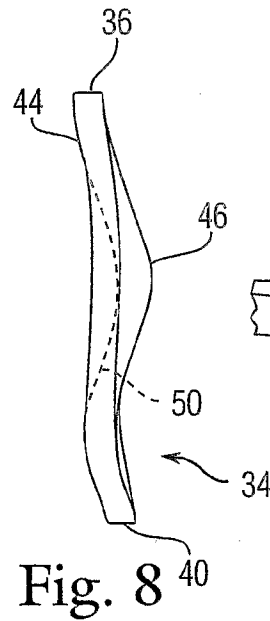
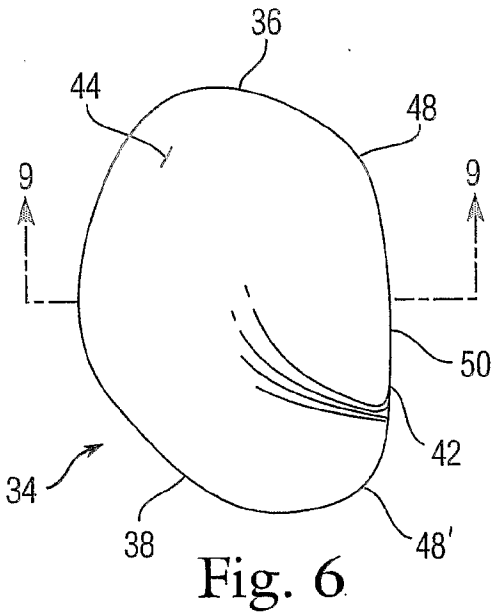
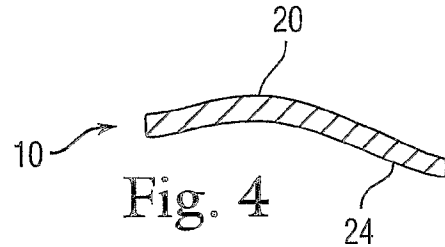
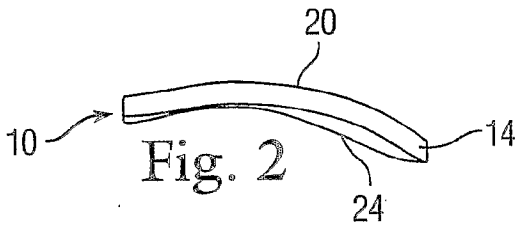
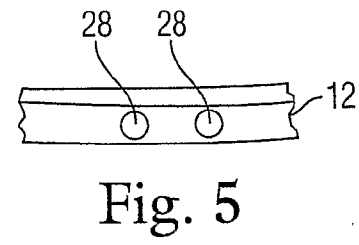
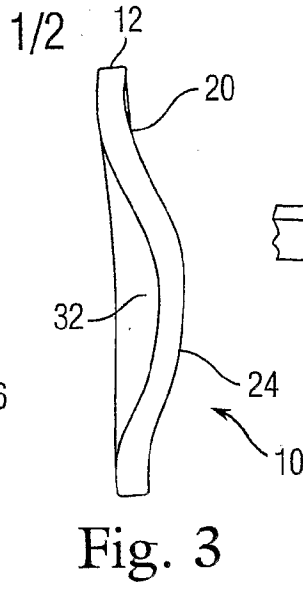
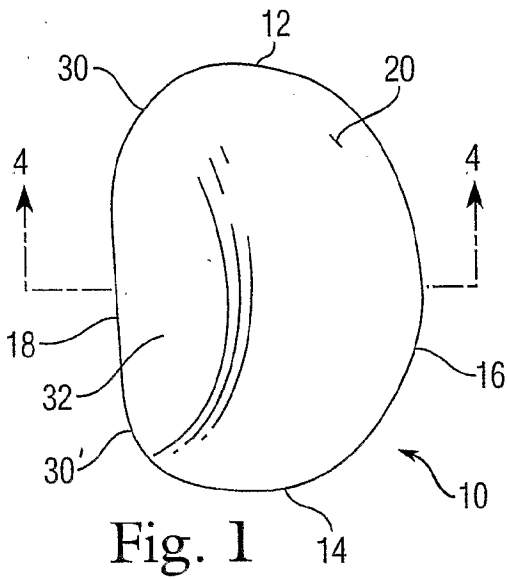

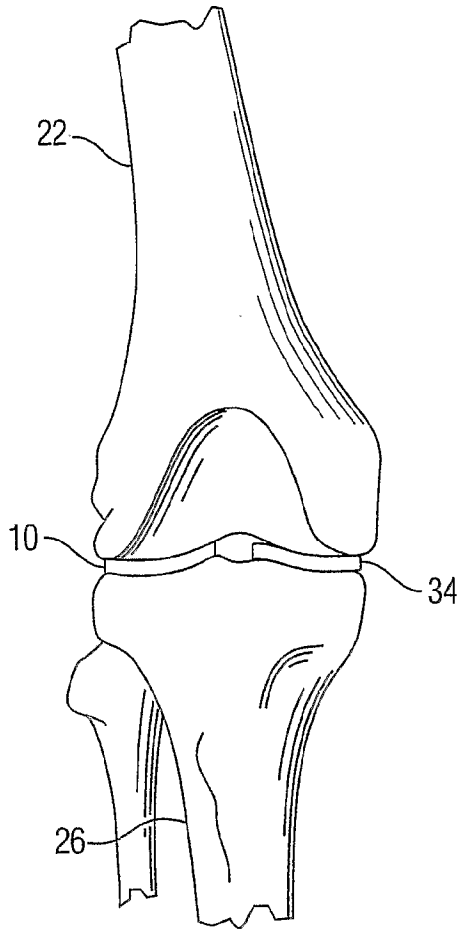

Fig. 11

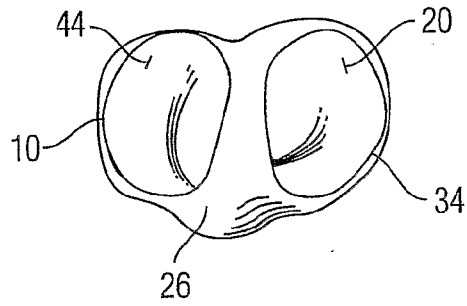

Fig. 12

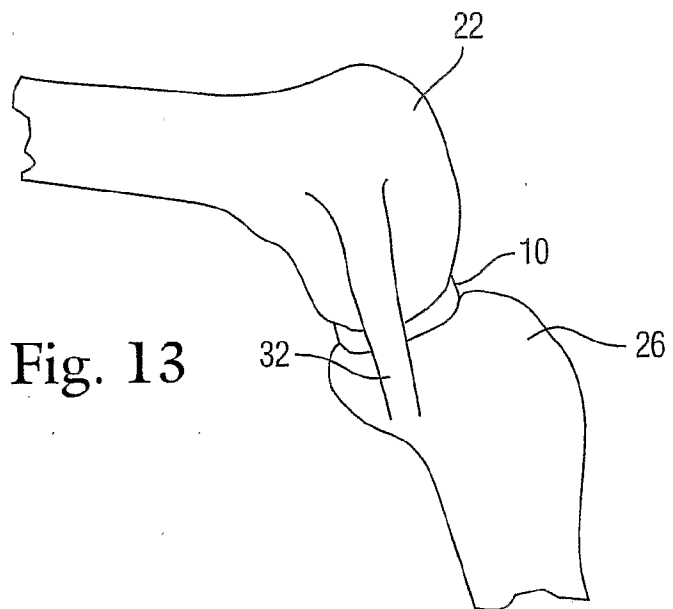

Fig. 13

(19) World Intellectual Property
Organization
International Bureau



(43) International Publication Date
2 September 2004 (02.09.2004)

PCT

(10) International Publication Number
WO 2004/073550 A3

(51) International Patent Classification⁷: A61F 02/08

GB, GD, GE, GH, GM, HR, HU, ID, IL, IN, IS, JP, KE, KG, KP, KR, KZ, LC, LK, LR, LS, LT, LU, LV, MA, MD, MG, MK, MN, MW, MX, MZ, NA, NI, NO, NZ, OM, PG, PH, PL, PT, RO, RU, SC, SD, SE, SG, SK, SL, SY, TJ, TM, TN, TR, TT, TZ, UA, UG, US, UZ, VC, VN, YU, ZA, ZM, ZW.

(21) International Application Number:
PCT/US2004/004596

(22) International Filing Date: 17 February 2004 (17.02.2004)

(25) Filing Language: English

(84) Designated States (unless otherwise indicated, for every kind of regional protection available): ARIPO (BW, GH, GM, KE, LS, MW, MZ, SD, SL, SZ, TZ, UG, ZM, ZW), Eurasian (AM, AZ, BY, KG, KZ, MD, RU, TJ, TM), European (AT, BE, BG, CH, CY, CZ, DE, DK, EE, ES, FI, FR, GB, GR, HU, IE, IT, LU, MC, NL, PT, RO, SE, SI, SK, TR), OAPI (BF, BJ, CF, CG, CI, CM, GA, GN, GQ, GW, ML, MR, NE, SN, TD, TG).

(26) Publication Language: English

(30) Priority Data:
60/448,599 20 February 2003 (20.02.2003) US

(71) Applicant and
(72) Inventor: MURRAY, Ian, P. [US/US]; 14351 Hampshire Knob Drive, Phoenix, MD 21131 (US).

Declaration under Rule 4.17:
— of inventorship (Rule 4.17(iv)) for US only

(74) Agent: GAMSON, Robert, M.; Armstrong, Kratz, Quintos, Hanson & Brooks, LLP, Intellectual Property Law Offices, 502 Washington Avenue, Suite 220, Towson, MD 21204 (US).

Published:
— with international search report

(81) Designated States (unless otherwise indicated, for every kind of national protection available): AE, AG, AL, AM, AT, AU, AZ, BA, BB, BG, BR, BW, BY, BZ, CA, CH, CN, CO, CR, CU, CZ, DE, DK, DM, DZ, EC, EE, EG, ES, FI,

(88) Date of publication of the international search report:
3 March 2005

For two-letter codes and other abbreviations, refer to the "Guidance Notes on Codes and Abbreviations" appearing at the beginning of each regular issue of the PCT Gazette.

(54) Title: KNEE SPACER

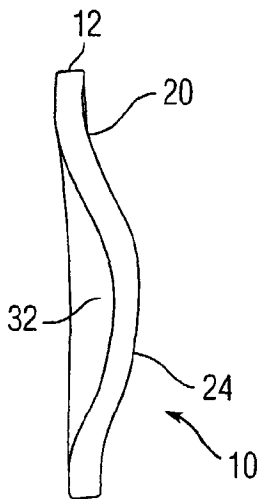

(57) Abstract: A spacer (10) for use in a knee which is kidney-shaped and has a concave femoral surface (20) and an opposite convex tibial surface (24). A pair of non-identical spacers (10 & 34) are provided for a knee. One spacer is disposed laterally and the other is disposed medially in the knee. The spacers (10 & 34) may be formed in a variety of sizes to be adapted to patients of different sizes. The spacers may be formed for the right knee and for the left knee.

WO 2004/073550 A3

INTERNATIONAL SEARCH REPORT

International application No.

PCT/US04/04596

A. CLASSIFICATION OF SUBJECT MATTER		
IPC(7) : A61F 02/8 US CL : 623/14.12		
According to International Patent Classification (IPC) or to both national classification and IPC		
B. FIELDS SEARCHED		
Minimum documentation searched (classification system followed by classification symbols) U.S. : 623/14.12		
Documentation searched other than minimum documentation to the extent that such documents are included in the fields searched		
Electronic data base consulted during the international search (name of data base and, where practicable, search terms used)		
C. DOCUMENTS CONSIDERED TO BE RELEVANT		
Category *	Citation of document, with indication, where appropriate, of the relevant passages	Relevant to claim No.
X	US 6,206,927 B1 (Fell et al) 27 March 2001 (27.03.2001), See figs. 5-9.	
Y		1-11
A, E	US 2004/0138754 A1 (Lang et al) 15 July 2004 (15.07.2004), See figs. 8C-8E.	1-11
<input type="checkbox"/> Further documents are listed in the continuation of Box C. <input type="checkbox"/> See patent family annex.		
* Special categories of cited documents:		
"A"	document defining the general state of the art which is not considered to be of particular relevance	"T" later document published after the international filing date or priority date and not in conflict with the application but cited to understand the principle or theory underlying the invention
"E"	earlier application or patent published on or after the international filing date	"X" document of particular relevance; the claimed invention cannot be considered novel or cannot be considered to involve an inventive step when the document is taken alone
"L"	document which may throw doubts on priority claim(s) or which is cited to establish the publication date of another citation or other special reason (as specified)	"Y" document of particular relevance; the claimed invention cannot be considered to involve an inventive step when the document is combined with one or more other such documents, such combination being obvious to a person skilled in the art
"O"	document referring to an oral disclosure, use, exhibition or other means	"&" document member of the same patent family
"P"	document published prior to the international filing date but later than the priority date claimed	
Date of the actual completion of the international search 22 July 2004 (22.07.2004)		Date of mailing of the international search report 01 NOV 2004
Name and mailing address of the ISA/US Mail Stop PCT, Attn: ISA/US Commissioner for Patents P.O. Box 1450 Alexandria, Virginia 22313-1450 Facsimile No. (703) 305-3230		Authorized officer <i>Sharon A. Greene for</i> Corrine McDermott Telephone No. 703-308-0858